



euroscreen®

Linea

The **Linea** model has a uniquely designed case with a classic yet contemporary shape. The gently rounded aluminium case has no exposed mounting fixtures or fasteners, and all attachment points are completely invisible. The case is finished in white and the heavy weight bottom dowel retracts completely inside the case when the screen is not in use.

Linea Tab Tension

This model features all of the benefits mentioned above, and an additional selection of tensioned screen surfaces. The tensioning function makes it possible to adjust the flatness of the surface and therefore provide a perfectly flat viewing surface for years to come.

SCREEN DIMENSIONS

SCREEN DIMENSIONS

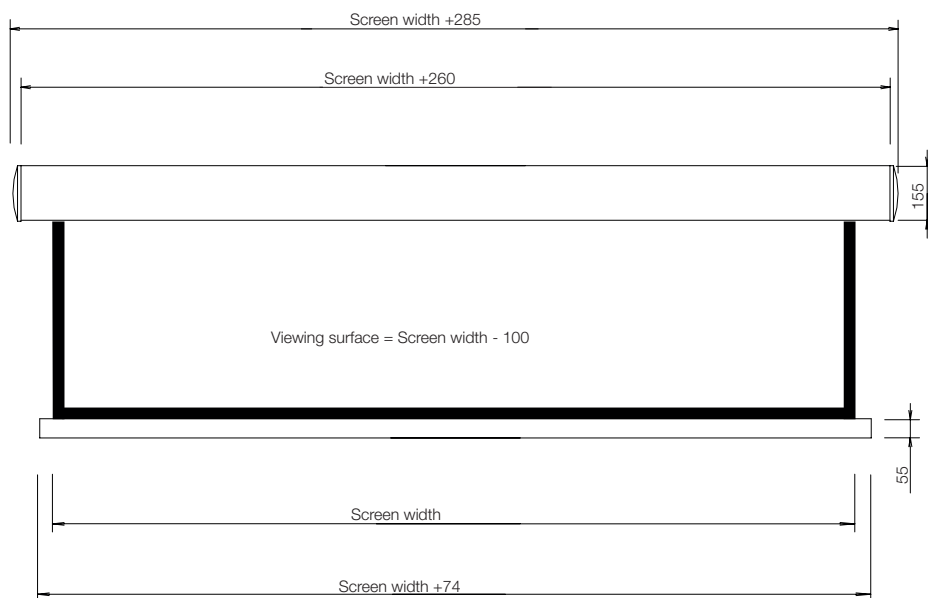

SCREEN SURFACES

Xpert

White front surface, black-backed. PVC free. Flame retardant (B1). Excellent surface flatness and colour temp. Gain 1,0.

MOTOR CONTROL

DRAPER-ER MOTOR

Built-in controls

- Draper-ER radio receiver
- Dry contact (RJ12 connector)

Accessories

- Radio remote controls
- Autolink
- Dry contact transmitter
- WiFi-box App-control
- IP-box

INSTALLATION/WIRED MOTOR

Accessories

- Control box (RS232, RF, IR,
- 12V trigger, Dry contact transmitter)

STANDARD FORMATS LINEA

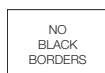

Available in sizes without black borders.



The screen has 5 cm wide black borders. The format of the viewing area is 16:9.

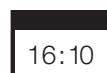

The screen has 5 cm wide black borders. The format of the viewing area is 16:10.



The screen has 5 cm wide black borders. The format of the viewing area is 2.35:1.

STANDARD FORMATS LINEA TT

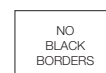

Available in sizes without black borders.



The screen has 5 cm wide black borders. The format of the viewing area is 16:9.



The screen has 5 cm wide black borders. The format of the viewing area is 16:10.



The screen has 5 cm wide black borders. The format of the viewing area is 2.35:1.

LINEA TAB TENSION

SCREEN DIMENSIONS

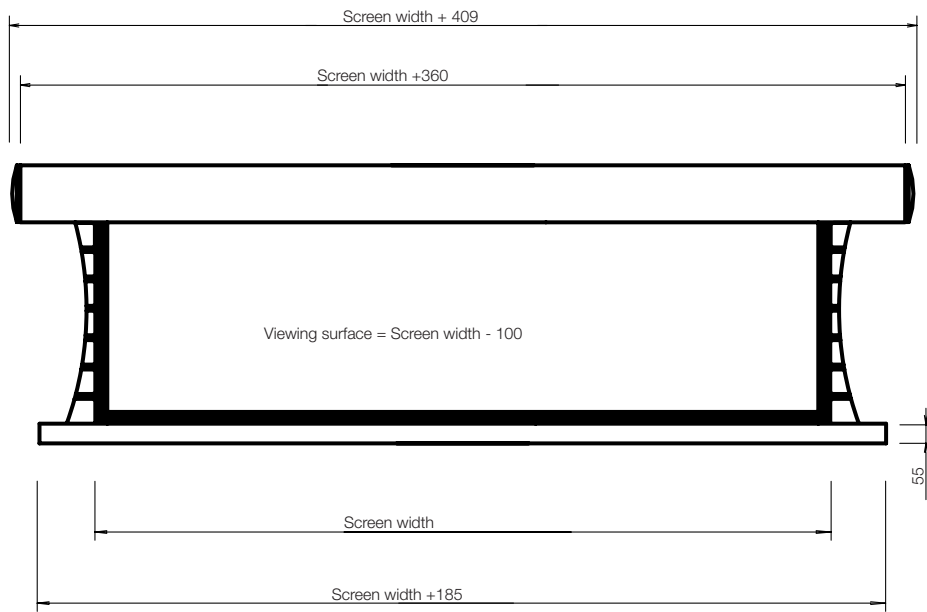

SCREEN SURFACES

FlexWhite

Pliable matt white front surface, superb colour rendition, Full HD & 8K compliant. Gain 1.0.

ReAct 3.0

Pliable silver grey front surface, enhances colour contrast in bright light, Full HD & 8K compliant. Gain 1.0.

FlexRear

Neutral grey rear projection surface. Full HD & 8K compliant. Gain 1.2.

FlexGrey

Grey front surface, Full HD & 8K compliant. Gain 0.8

CASE DIMENSIONS

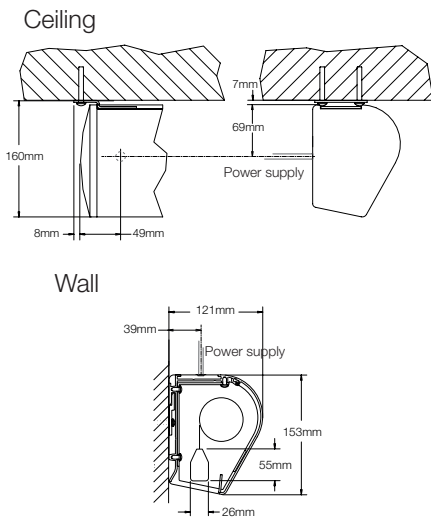

BRACKET DIMENSIONS

Brackets - Wall

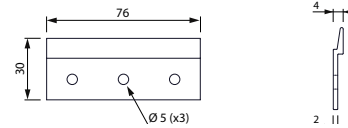

Brackets - Ceiling

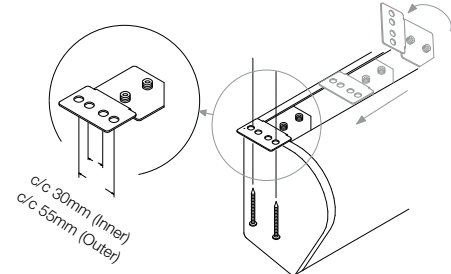

PACKAGING DIMENSIONS LINEA

Screen width	Box length	Box width	Box height
1600	2150	260	260
1800	2350	260	260
2000	2550	260	260
2200	2750	260	260
2400	2950	260	260
2700	3250	260	260
3000	3550	260	260

PACKAGING DIMENSIONS LINEA TT

Screen width	Box length	Box width	Box height
1600	2260	260	260
1800	2460	260	260
2000	2660	260	260
2200	2860	260	260
2400	3060	260	260
2700	3360	260	260
3000	3660	260	260